



## AIR HYDRAULIC PUMP

Max. Pressure: See Pump Data Plate

Workstation Sound Pressure Level: 80 dB(A) at Rated Capacity

**Definition:** An air hydraulic pump delivers hydraulic fluid under pressure through the use of compressed air as a power source.

### SAFETY EXPLANATIONS

Two safety symbols are used to identify any action or lack of action that can cause personal injury. Your reading and understanding of these safety symbols is very important.



**DANGER** - Danger is used only when your action or lack of action will cause serious human injury or death.



**WARNING** - Warning is used to describe any action or lack of action where a serious injury can occur.

**IMPORTANT** - Important is used when action or lack of action can cause equipment failure, either immediate or over a long period of time.



**WARNING:** It is the operator's responsibility to read and understand the following safety statements,

- Only qualified operators should install, operate, adjust, maintain, clean, repair, or transport this machinery.
- These components are designed for general use in normal environments. These components are not specifically designed for lifting and moving people, agri-food machinery, certain types of mobile machinery or special work environments such as: explosive, flammable or corrosive. Only the user can decide the suitability of this machinery in these conditions or extreme environments. Power Team will supply information necessary to help make these decisions.

These instructions are intended for end-user application needs. Most problems with new equipment are caused by improper operation or installation. Detailed service repair instructions or parts lists can be obtained from your nearest Power Team facility (see listing).

## SAFETY PRECAUTIONS

### **WARNING**

#### General Operation

- All **WARNING** statements must be carefully observed to help prevent personal injury.
- Before operating the pump, all hose connections must be tightened with the proper tools. Do not overtighten. Connections should only be tightened securely and leak-free. Overtightening can cause premature thread failure or high pressure fittings to split at pressures lower than their rated capacities.
- Should a hydraulic hose ever rupture, burst, or need to be disconnected, immediately shut off the pump and release all pressure. Never attempt to grasp a leaking pressurized hose with your hands. The force of escaping hydraulic fluid could cause serious injury.
- Do not subject the hose to potential hazard such as fire, sharp surfaces, extreme heat or cold, or heavy impact. Do not allow the hose to be altered or kink, twist, curl, crush, cut, or bend so tightly that the fluid flow within the hose is blocked or reduced. Periodically inspect the hose for wear, because any of these conditions can damage the hose and possibly result in personal injury.
- Do not use the hose to move attached equipment. Stress can damage hose and possibly cause personal injury.
- Hose material and coupler seals must be compatible with the hydraulic fluid used. Hoses also must not come in contact with corrosive materials such as creosote-impregnated objects and some paints. Consult the manufacturer before painting a hose. Hose deterioration due to corrosive materials can result in personal injury. Never paint the couplers.
- Inspect machine for wear, damage, and correct function before each use. Do not use machinery that is not in proper working order, but repair or replace it as necessary.
- Replace worn or damaged safety decals.
- Modification of a product requires written Power Team authorization.
- Use only components with the same pressure rating when assembling a system or machine.

#### Pump

- Do not exceed the hydraulic pressure rating noted on the pump data plate or tamper with the internal high pressure relief valve. Creating pressure beyond the rated pressure can result in personal injury.
- Before replenishing the fluid level, retract the system to prevent overfilling the pump reservoir. An overfill can cause personal injury due to excess reservoir pressure created when cylinders are retracted.

#### Air Supply

- Shut off and disconnect the air supply when the pump is not in use or before breaking any connections in the system.

## PREPARATION & SET-UP

### Air Supply Hook-Up

Remove the thread protector from the air inlet of the pump. Select and install the threaded fittings which are compatible with your air supply fittings. The air supply should be 20 CFM (.57 M<sup>3</sup>/min.) and 100 PSI (7 BAR) at the pump to obtain the rated hydraulic pressure. Air pressure should be regulated to a maximum of 140 PSI (9 BAR). Secure your pump fitting to the air supply. See illustrations on following pages.



**WARNING:** If improperly used, pressurized equipment can be potentially hazardous. Therefore:

- Hydraulic connections must be securely fastened before building pressure in the system.
- Release all system pressure before loosening any hydraulic connection in the system.

**Hydraulic Connections**

Clean all the areas around the fluid ports of the pump and cylinder. Inspect all threads and fittings for signs of wear or damage and replace as needed. Clean all hose ends, couplers and union ends. Remove the thread protectors from the hydraulic fluid outlets. Connect the hose assembly to the hydraulic fluid outlet and couple the hose to the cylinder. See illustrations below.

**IMPORTANT:** Seal all external pipe connections with a high grade, nonhardening thread sealant. Teflon tape may also be used to seal hydraulic connections, provided only one layer of tape is used. Apply the tape carefully, two threads back, to prevent it from being pinched by the coupler and broken off inside the system. Any loose pieces of tape could travel through the system and obstruct the flow of fluid or cause jamming of precision-fit parts.

**For Hand/Foot Operated Pumps:**

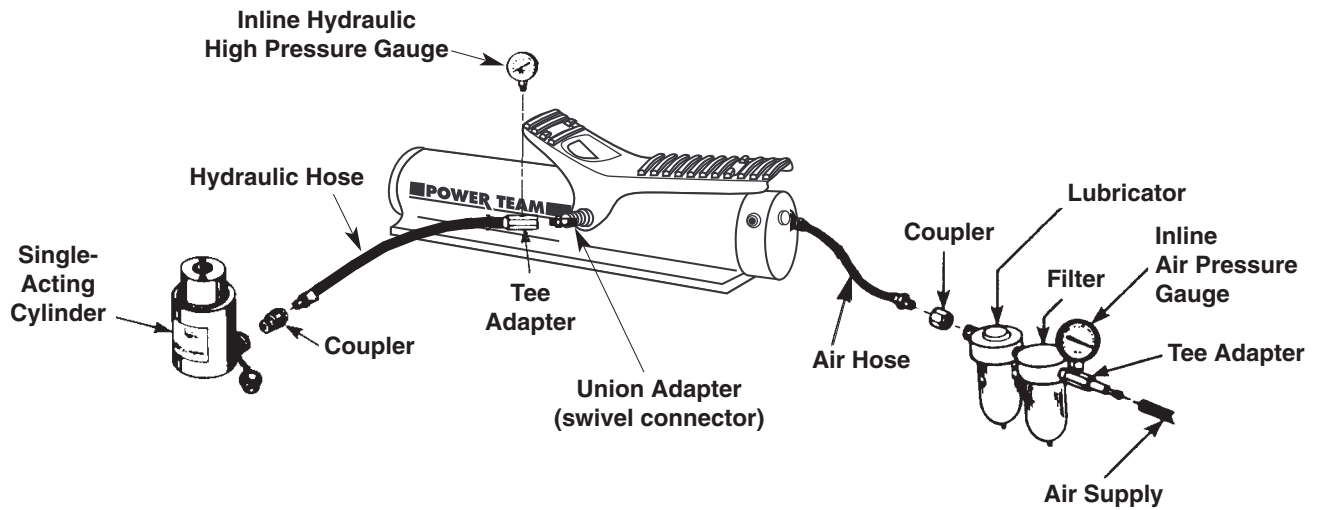

**For Push Button Operated Pumps:**

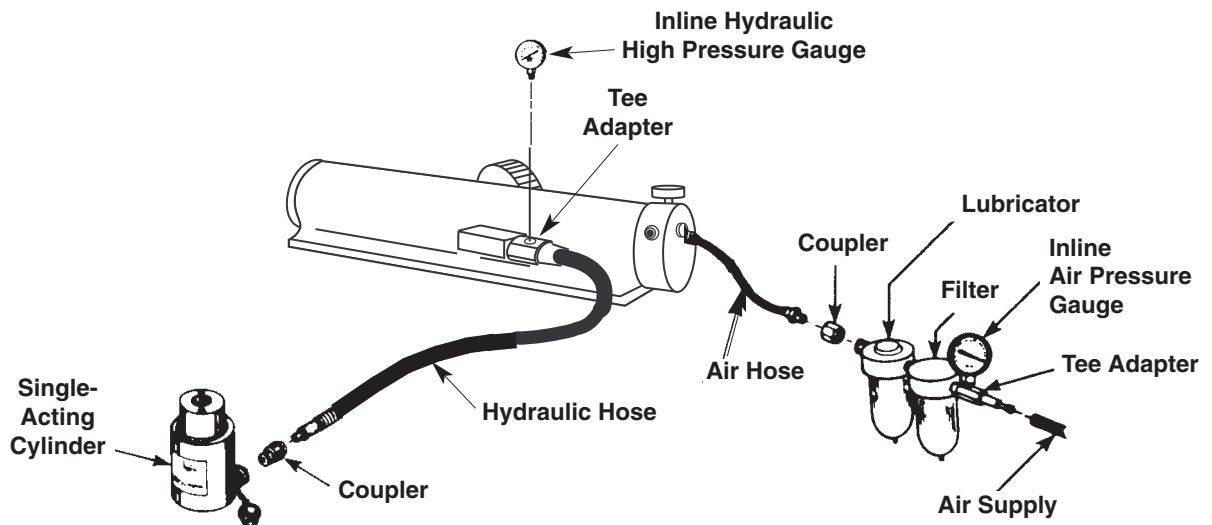

## OPERATION

### PICTOGRAM DEFINITIONS

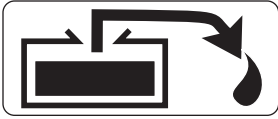

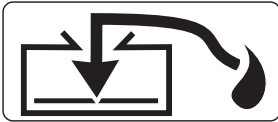

Activating the pump with the pedal end marked with this pictogram, the flow of fluid is directed out of the reservoir.





Activating the pump with the pedal end marked with this pictogram, the flow of fluid is directed back to the reservoir.

### Pump Operation

#### For Hand/Foot Operated Pumps:

1. To extend the cylinder, depress the pedal on the end marked .
2. To hold the cylinder in position, release the end of foot pedal marked with  to deactivate the pump.
3. To retract the cylinder, depress the pedal on the end marked .

#### For Push Button Pumps:

1. To extend the cylinder, depress the button on the remote hand control marked .
2. To hold the cylinder in position, release the  button.
3. To retract the cylinder, depress the button on the remote hand control marked .

#### For Pumps With Air Regulators:

1. Open the air shut-off valve (if so equipped) or connect the air quick coupler (if so equipped).  
**NOTE: under certain circumstances the pump may need to be primed before operation. Refer to the method described in the section entitled "Priming the Pump Unit."**
2. Slowly turn the air regulator control on unit clockwise to increase pressure, counterclockwise to decrease pressure. As air is admitted to the pump unit, it will begin to deliver fluid to the system. Continue to slowly turn the air regulator control clockwise until gauge reads the maximum hydraulic pressure rating as stated on the pumps data plate. A maximum hydraulic pressure reading should be obtained if air pressure is approximately 100 PSI (7 BAR).
3. Cycle the system several times by manually shifting or the push button (if so equipped). Set the air regulator to obtain the desired hydraulic pressure. When decreasing pressure, shift the valve after each adjustment before measuring actual hydraulic pressure.
4. Shut off and disconnect air supply to the pump and shift pump valve or push button (if so equipped) two times to release all system pressure. Check fluid level with hydraulic system retracted. The pump is now ready for operation.

**NOTE:**

- The hydraulic pressure is increased or decreased by adjusting the air inlet pressure at the regulator.

- On two stage pumps, the air pressure regulator that is mounted on the pump controls only the output from the high pressure stage. The output of the low pressure stage of the pump is determined by the air line pressure coming from the remote regulator. A remote regulator is required to control the air pressure from the air line. The independent functioning of the low and high pressure stages of this pump can best be described as follows. At the minimum air line pressure of 40 PSI (3 BAR), the low pressure stage of the pump will deliver 480 PSI (33 BAR) hydraulic pressure (with the pump regulator turned counterclockwise to prevent air pressure from activating the high pressure stage of the pump.) At the minimum air line pressure of 40 PSI (3 BAR) the high pressure stage of the pump will deliver 4,000 PSI (275 BAR) hydraulic pressure (with the pump regulator turned clockwise to allow air pressure to reach the high pressure stage.) Always remember that the pump regulator must be turned fully counterclockwise when the pump is used to produce 1,200 PSI (83 BAR) or less.

## OPERATION (CONTINUED)

### Adjusting The Release Mechanism

1. Loosen the "Adjusting Screw".
2. Verify that the "Adjusting Plate" is free.
3. Depress the "Air Inlet Stem" with the "Foot Pedal". The pump will now run and build pressure.
4. Release the "Foot Pedal". The pump will stop running, but the hydraulic pressure will be held.
5. With the "Foot Pedal" resting on the "Air Inlet Stem" rotate the "Adjusting Plate" clockwise until a stop is felt.

**Note:** If the end of the slot in the "Adjusting Plate" is met before a stop is felt, the "Adjusting Plate" must be repositioned one step counterclockwise on the "Hex Stem", then repeat step #5.

6. Tighten the "Adjusting Screw". The release mechanism is now properly set.

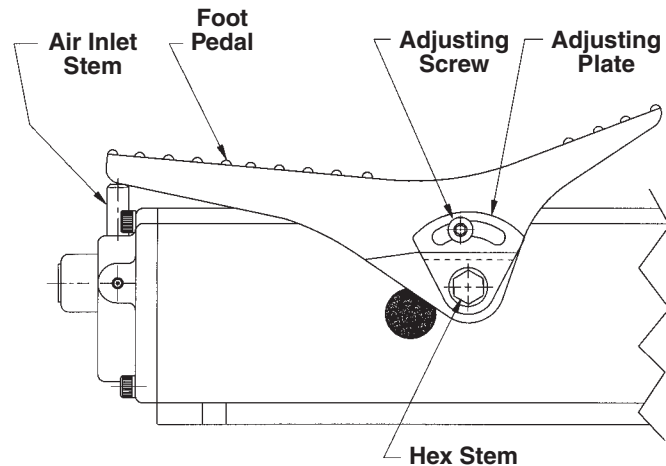

## PREVENTIVE MAINTENANCE

- IMPORTANT:**
- Any repair or servicing that requires dismantling the pump must be performed in a dirt-free environment by a qualified technician.
  - Dispose of machine and oil properly.

### Lubrication

#### For Hand/Foot and Push Button Operated Pumps:

If the pump is operated on a continuous duty cycle for extended periods, the manufacturer recommends installing an automatic air line oiler in the air inlet line as close to the pumping unit as possible. Set the unit to feed approximately one drop of oil per minute into the system. Use SAE grade oil (5W to 30W).

### Bleeding Air From The System

During the first moments of operation or after prolonged use, a significant amount of air may accumulate within the hydraulic system. This entrapped air may cause the cylinder to respond slowly or behave in an unstable manner. To remove the air, run the system through several cycles (extending and retracting the cylinder) free of any load. The cylinder must be at lower level than the pump to allow air to be released through the pump bladder.

### Inspecting The Hydraulic Oil Level

Check the oil level in the bladder after every 10 hours of use. Drain and replenish the bladder with Power Team hydraulic oil after every 300 hours of use approximately.

Note: Shaded areas reflect last revision(s) made to this form.

## PREVENTIVE MAINTENANCE (CONTINUED)

### Draining And Flushing The Reservoir

**IMPORTANT: Wipe the pump exterior completely clean before attempting this procedure!**

1. Drain the bladder of all oil and refill half full with clean hydraulic oil. Rinse the filter clean.
2. Run the unit for several minutes.
3. Drain and clean the bladder once more.
4. Refill the bladder with Power Team hydraulic oil.

**IMPORTANT: Drain and clean the other hydraulic system components (hoses, cylinders, etc.) before reconnecting them to the pump. This will prevent contaminated fluid from entering the pump again.**

### Refilling The Bladder

If additional oil must be added to the bladder, use only Power Team hydraulic oil (215 SSU @ 100° F [38° C]). Clean the entire area around the filler plug before adding oil to the bladder. Remove the filler plug, and insert a clean funnel with filter. The cylinder must be fully retracted and the air supply disconnected when adding the oil to the bladder.

### Periodic Cleaning

**IMPORTANT: The greatest single cause of failure in hydraulic pumps is dirt. Keep the pump and attached equipment clean to prevent foreign matter from entering the system.**

A routine should be established to keep the pump as free from dirt as possible. All unused couplers must be sealed with thread protectors. All hose connections must be free of grit and grime. Any equipment hooked up to the pump should also be kept clean. Use only Power Team hydraulic oil in this unit and change as recommended (every 300 hours).

## ACCESSORIES

Gauges and accessories may not be included with the pump. However, a hydraulic gauge is strongly recommended whenever the pump is used!



- WARNING:**
- The gauge must be of the proper rating for the pressure used!
  - Use only Power Team approved accessories, hydraulic oil, and repair parts!

### Installing An In-line Air Pressure Gauge

1. Remove the male fitting from the air filter and install a tee adapter, with gauge, between the hose and air filter.
2. Install male fitting into the tee adapter and securely clamp the hose to the male fitting.

### Installing An In-line Hydraulic Pressure Gauge

1. Remove the thread protector from the hydraulic outlet port and inspect the threads and fittings for signs of wear.
2. Install a tee adapter, with gauge, between the hose coupling and the pump hydraulic outlet port.
3. Tighten all connections securely! **DO NOT OVERTIGHTEN HOSE CONNECTIONS.**

### Fire-Resistant Hydraulic Fluid

Flame Out 220™ fire-resistant hydraulic fluid is compatible with all Power Team hydraulic equipment. The use of this fluid does not require the changing of seals in any Power Team pump or cylinder and is available through your local Power Team distributor.

**OPERATOR TROUBLESHOOTING GUIDE**

If this guide does not resolve your pump problem,  
 contact an authorized hydraulic service center or a company headquarters listed on back sheet 4 of 4.

<b>PROBLEM</b>	<b>CAUSE</b>	<b>SOLUTION</b>
<b>Pump reciprocates but no oil delivery (cylinder will not extend)</b>	1. Low oil level. 2. Release improperly adjusted.	1. Add oil as instructed in Preventive Maintenance section. 2. See adjustment instructions.
<b>Low fluid delivery (cylinder extends slowly)</b>	1. Inadequate air supply a. Check air input supply. b. Contamination, check air side of pump (plugged air inlet screen). 2. Hydraulic failure a. Air in hydraulic system. 3. Release improperly adjusted.	1. a. Should be 20 CFM (.57 M <sup>3</sup> /min.) minimum. b. Clean and reassemble. 2. a. Remove reservoir and clean intake filter and reinstall. 3. See adjustment instructions.
<b>Pump will not build to maximum pressure (no visible leakage)</b>	1. Check the air supply. 2. Pressure regulator improperly adjusted (if so equipped). 3. Release improperly adjusted.	1. 100 PSI (7 BAR) is required to obtain maximum pressure. 2. Adjust according to instructions in Operation section. 3. See adjustment instructions.
<b>Pump builds pressure but will not hold system pressure</b>	1. Check the hydraulic connections and other system components for leakage, including 3 way/4 way valve (if so equipped). 2. Release improperly adjusted.	1. Refit or repair as needed. 2. See adjustment instructions.
<b>Pump will continue to run slowly even after desired pressure is reached.</b>	1. Output pressure equal to or higher than relief valve setting.	1. Normal operation.
<b>Excess oil spray from muffler.</b>	1. Air lubricator is set too rich (if so equipped).	1. Set at one drop per minute.
<b>Pump will release not release pressure</b>	1. Release improperly adjusted.	1. See adjustment instructions.

## POWER TEAM FACILITIES



**UNITED STATES**

*SPX Corporation-Fluid Power  
5885 11th Street  
Rockford, IL 61109-3699  
USA  
Telephone: 1-815-874-5556  
FAX: 1-815-874-7853*

***Cust. Service/Order Entry***

***Tel: 1-800-541-1418  
FAX: 1-800-288-7031***

***E-mail:***

***info@fluidpower.spx.com***

***Technical Services***

***Tel: 1-800-477-8326  
FAX: 1-800-765-8326***



**CHINA**

*212 Jiang Ning Road  
CATIC Tower 23C  
Shanghai 200041, China  
Tel: 86 (21) 5289 5858  
FAX: 86 (21) 5289 5866  
E-mail:  
info.asia@fluidpower.spx.com*



**FAR EAST**

*7 Gul Circle  
Singapore 629563  
Singapore  
Tel: (65) 6265-3343  
FAX: (65) 6265-6646  
E-mail:  
info.asia@fluidpower.spx.com*



**EUROPE**

*Albert Thijsstraat 12  
6471 WX Eyselshoven  
Netherlands  
Tel: 31 (45) 5678877  
FAX: 31 (45) 5678878  
E-mail  
info.europe@fluidpower.spx.com*

For more information, Internet address: <http://www.powerteam.com> (or) <http://www.hytec.com>



## EC Declaration of Incorporation

as defined by  
European Communities Directive 89/392/EEC, Annex II(B)

MANUFACTURER'S NAME:

**SPX FLUID POWER**

MANUFACTURER'S ADDRESS:

5885 11th Street  
Rockford, Illinois 61109  
USA

Telephone: 815-874-5556  
Fax: 815-874-7853

TYPE OF EQUIPMENT: RECIPROCATING AIR PISTON HYDRAULIC PUMP.

ORDER NUMBER OR PART NUMBER: PA9 Series

APPLICATION OF EC COUNCIL DIRECTIVE(S): 89/392/EEC as amended by 91/368/EEC, 93/44/EEC, and 93/68/EEC.

STANDARD(S) TO WHICH CONFORMITY IS DECLARED: EN292-1, and EN292-2.

*I, the undersigned, hereby declare that the equipment specified above conforms to the above European Communities Directive(s) and Standard(s). This product is not to be put into service until the machine has been declared in conformity with the provisions of the European Communities Directive(s).*

PLACE: Rockford, Illinois USA



(Signature)

DATE:

24 AUG 2005  
(date / month / year)

Don Blackman  
Director of Engineering