

Length (A) inches (mm)	Width (B) inches (mm)	Height (C) inches (mm)
8 ⁷ / ₁₆ (214)	8 ¹ / ₂ (216)	16 ³ / ₄ (425)

Grip Range (D) inches (mm)	Net weight lbs (kg)	WLL* lbs (kg)
1 ³ / ₁₆ ~ 2 ¹⁵ / ₁₆ (30 ~ 75)	62.04 (28.2)	3300 (1500)

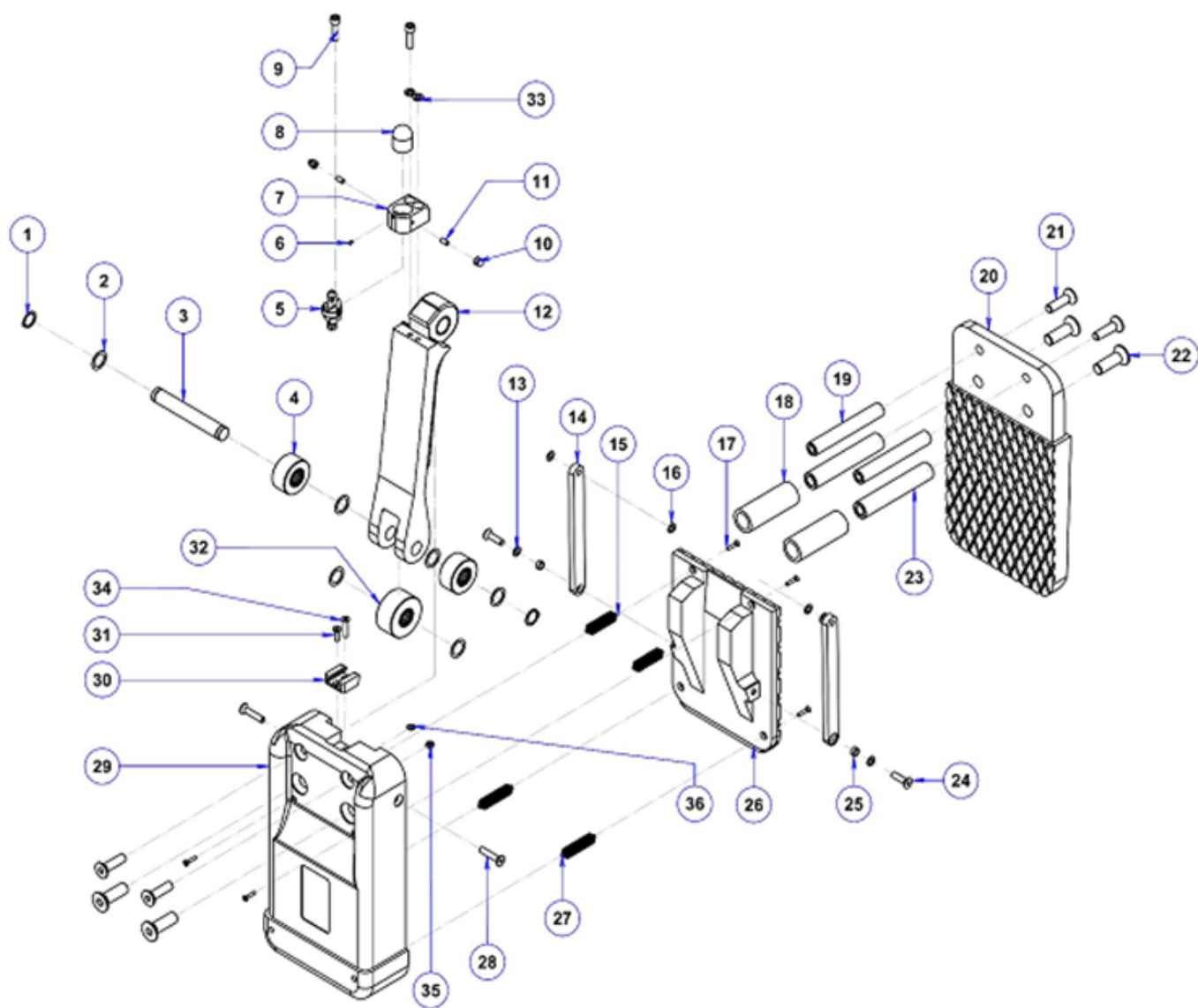















* WLL: Work load limit







SPARE PART LIST

Name: ABACO LITTLE GIANT LIFTER AUTOMATIC

Mode: ALG75A

Code	Description	Image	Unit	Qty.
ALG75A-01	Circlip Ø20		pcs	2
ALG75A-02	Brass washer Ø20		pcs	6
ALG75A-03	Shaft of roller		pcs	1
ALG75A-04	Outer roller		pcs	2
ALG75A-05	Automatic locking latch		set	1
ALG75A-06	Allen set screw M4 x 6		pcs	1
ALG75A-07	Base, auto lock		pcs	1
ALG75A-08	Cover		pcs	1
ALG75A-09	Allen bolt M8 x 30		pcs	2
ALG75A-10	Cap nut M6		pcs	2
ALG75A-11	Allen set screw M6 x 16		pcs	2
ALG75A-12	Lifting pin		pcs	1
ALG75A-13	Washer Ø8		pcs	2
ALG75A-14	Linker		pcs	2
ALG75A-15	Top extension spring		pcs	2
ALG75A-16	Washer Ø8 x Ø14 x 0.8		pcs	4

ALG75A-17	Screw M4 x 20		pcs	8
ALG75A-18	Rubber tube		pcs	2
ALG75A-19	Top pin		pcs	2
ALG75A-20	Clamp back plate		pcs	1
ALG75A-21	Allen bolt countersunk M12 x 40		pcs	4
ALG75A-22	Allen bolt countersunk M16 x 50		pcs	4
ALG75A-23	Bottom pin		pcs	2
ALG75A-24	Allen bolt countersunk M8 x 30		pcs	2
ALG75A-25	Spacer		pcs	2
ALG75A-26	Clamp center plate		pcs	1
ALG75A-27	Bottom extension spring		pcs	2
ALG75A-28	Allen bolt countersunk M8 x 40		pcs	2
ALG75A-29	Main housing		pcs	1
ALG75A-30	Receptacle (automatic lock)		pcs	1
ALG75A-31	Allen bolt countersunk M6 x 20		pcs	1
ALG75A-32	Inner roller		pcs	1
ALG75A-33	Spring washer Ø8		pcs	2

ALG75A-34	Allen bolt countersunk M6 x 30		pcs	1
ALG75A-35	Nut M6		pcs	1
ALG75A-36	Washer Ø6		pcs	1
	Swivel Shackle		pcs	1